

Technical Datasheet

V-Port Control Ball Valves DIN & ANSI Ball Valves

JC
VALVES

The quality option

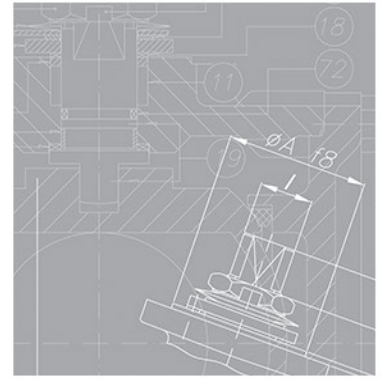

sales@jc-valves.com

www.jc-valves.com

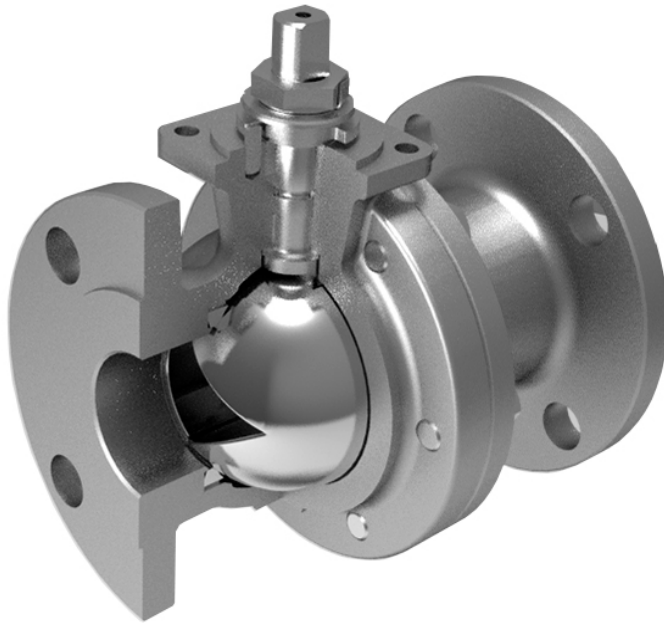

FUGITIVE EMISSIONS
EN-ISO 15848-1
TALUFT / VDI 2440



- Split Body Construction (3 pieces under request)
- Regulating bore
- Soft seat / Metal Seat
- Design API6D / ASME B16.34 / EN 12156 / ISO 5208
- ISO 5211
- Connections: Flanged (other under request)
- Shell finishing quality: MSS SP 55
- Testing API 598 / API 6D / EN 12266 / ISO 52008
- Materials according to NACE MR0175 / MR0103

V-Port Ball Valves are a unique design that combines the excellent sealing and design features of ball valves with the ability to be used as control valves, providing a reliable and accurate flow control. JC produces V-Port valves in both DIN and ANSI standards, in a wide range of materials, with soft and metal seats.

Main advantages of JC V-Port ball valves:

- Low Pressure Drop
- Easy Maintenance
- Tight Shut Off
- High Shut Off Pressure
- Lower Torque

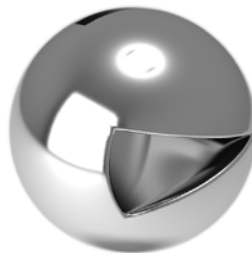

V-PORT 30°

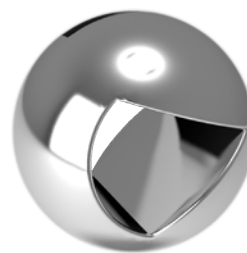

V-PORT 60°

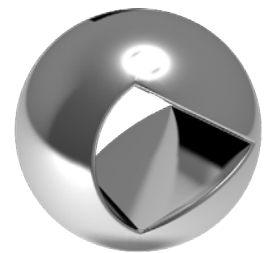

V-PORT 90°

There are different ball constructions. The 30° option allows for a finer tapered control throughout the valve rotation, while the 60° and 90° offer a larger Cv in addition to a controlled flow.

V-Port Control Ball Valves

Flow Control Information

DIN & ANSI Ball Valves

Flow Control Information

DN	Ball Angle	0%	15%	20%	30%	40%	50%	60%	70%	80%	90%	100%
15 (1/2")	30	0	0,1	0,1	0,2	0,3	0,5	0,8	1,1	1,6	2,2	2,6
	60	0	0,1	0,1	0,3	0,5	0,9	1,4	2	3,3	4,4	6
	90	0	0,1	0,2	0,4	0,6	0,9	1,5	2,2	3,8	5,4	6,9
20 (3/4")	30	0	0,1	0,2	0,5	0,7	1,1	1,8	2,4	3,3	4,5	5,4
	60	0	0,1	0,2	0,7	1	1,7	2,8	4	6,5	9	12
	90	0	0,2	0,4	0,8	1,2	2	3,1	4,6	8	11,3	14
25 (1")	30	0	0,1	0,3	0,8	1,3	2,3	3,5	5,1	8,5	9,8	10
	60	0	0,2	0,4	1,1	1,8	3,4	5,3	7,9	12,3	15,3	21
	90	0	0,2	0,6	1,8	3,4	5,1	8,1	11,4	16	21	29
32 (1 1/4")	30	0	0,2	0,4	1,1	2	3,7	5,5	8	10	13	15
	60	0	0,2	0,6	1,8	3	5,5	9,5	12,8	19	26	39
	90	0	0,3	0,8	2	5	8	14	19	28	39	55
40 (1 1/2")	30	0	0,3	0,6	1,6	3	5	7,5	11	14	17	20
	60	0	0,4	0,8	2,5	4	8	13	19	27	40	52
	90	0	0,4	0,9	3,5	7	13	20	31	42	63	78
50 (2")	30	0	0,4	1,2	3,8	6	10	15	23	31	43	60
	60	0	0,4	1,5	4,6	9	16,5	27	39	55	83	110
	90	0	0,5	2	6	12	22	35	45	70	105	135
65 (2 1/2")	30	0	0,4	1	4	8	12	18	28	37	62	75
	60	0	0,4	1,5	5	10	21	34	53	75	103	150
	90	0	0,5	1,7	7	14	28	48	70	106	160	218
80 (3")	30	0	0,5	1,2	4	8	14	23	33	46	65	82
	60	0	0,5	2,5	6	14	25	40	65	91	128	165
	90	0	0,7	3,5	8	18	35	60	90	135	205	310
100 (4")	30	0	0,6	2	6	15	29	48	71	100	130	159
	60	0	0,7	3	11	25	40	59	90	141	212	356
	90	0	1	3,5	16	40	75	125	190	295	442	670
125 (5")	30	0	0,8	2,6	10	24	45	76	113	160	205	255
	60	0	1,4	4	17	43	75	125	188	279	399	578
	90	0	2	5,8	26	65	118	203	308	473	706	1.075
150 (6")	30	0	0,9	3,2	14	33	60	103	155	220	280	350
	60	0	2	5	22	60	110	190	285	416	586	800
	90	0	3	8	35	90	160	280	425	650	970	1.480
200 (8")	30	0	1,2	4,3	19	44	80	137	206	293	372	466
	60	0	2,7	6,7	29	80	146	253	379	553	779	1.064
	90	0	4	11	47	120	213	372	565	865	1.290	1.968

Note: Kv=0.862Cv

V-Port Control Ball Valves

Face to Face Dimensions

DIN & ANSI Ball Valves

F l o a t i n g

DN	Fig. 515	Fig. 530	Fig. 316	Fig. 340	Fig. 516	Fig. 540
	Acc. ASME B16.10		Acc. EN 558 Series 1		Acc. EN 558 Series 27	
15 (1/2")	108	140	--	130	--	115
20 (3/4")	117	152	--	150	--	120
25 (1")	127	165	--	160	--	125
32 (1 1/4")	--	--	--	180	--	130
40 (1 1/2")	165	190	--	200	--	140
50 (2")	178	216	--	230	--	150
65 (2 1/2")	190	--	290	290	170	170
80 (3")	203	282	310	310	180	180
100 (4")	229	305	350	350	190	190
125 (5")	--	--	400	400	325	325
150 (6")	394	403	480	480	350	350
200 (8")	457	--	600	--	400	---

Dimensions in mm

Free Stem Dimensions

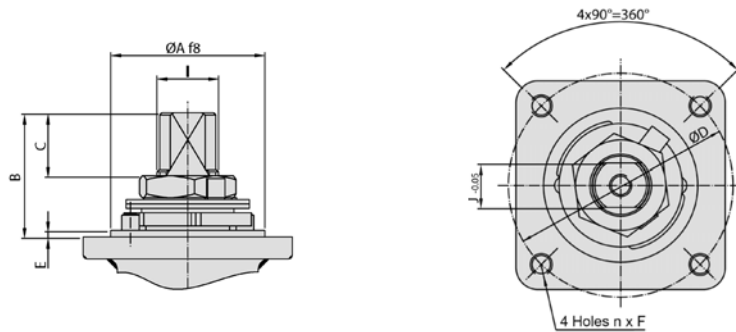

Stem Dimensions									
DN	ISO	ØA	B	C	ØD	n x F	E	I	J
15 (1/2")	F05	35	11,2	5,0	50	4 x M6	1,5	M12x1,5	9
20 (3/4")	F05	35	14,7	8,5	50	4 x M6	1,5	M12x1,5	9
25 (1")	F05	35	22,7	9,5	50	4 x M6	1,5	M12x1,5	9
32 (1 1/4")	F05	35	32,0	13,0	50	4 x M6	1,5	M16x1,5	12
40 (1 1/2")	F07	55	41,5	18,3	70	4 x M8	3	M18x1,5	13
50 (2")	F07	55	41,5	18,3	70	4 x M8	3	M18x1,5	13
65 (2 1/2")	F07	55	44,0	18,6	70	4 x M8	3	M22x1,5	16
80 (3")	F10	70	44,5	18,6	102	4 x M10	3	M25x1,5	18
100 (4")	F10	70	56,5	27,8	102	4 x M10	3	M28x1,5	20
125 (5")	F12	85	56,0	24,8	125	4 x M12	3	M35x2	25
150 (6")	F12	85	68,0	37,1	125	4 x M12	3	M40x2	29
200 (8")	F14	100	72,0	36,5	140	4 x M16	4	M45x2	32

Dimensions in mm

V-Port Control Ball Valves

Torque & Mast Values in Nm

DIN & ANSI Ball Valves

F l o a t i n g

Seat Material: PTFE + S.S.							
DN	Break To Open (B.T.O.)				M.A.S.T.		
	Fig. 515	Fig. 530	Fig. 316 & 516	Fig. 340 & 540	A182 Gr. F51	A479 XM-19	17-4 PH
15 (1/2")	10	15	--	13	57	92	92
20 (3/4")	14	19	--	17	57	92	92
25 (1")	18	22	--	20	57	92	92
32 (1 1/4")	--	--	--	28	151	245	245
40 (1 1/2")	38	44	--	42	185	299	299
50 (2")	65	74	--	67	185	299	299
65 (2 1/2")	98	--	95	105	386	623	623
80 (3")	160	190	153	169	539	871	871
100 (4")	193	330	185	299	668	1.079	1.079
125 (5")	--	--	340	427	1.329	2.148	2.148
150 (6")	463	910	427	575	2.131	3.445	3.445
200 (8")	1.135	--	979	--	3.034	3.484	4.904

Pressure – Temperature Charts

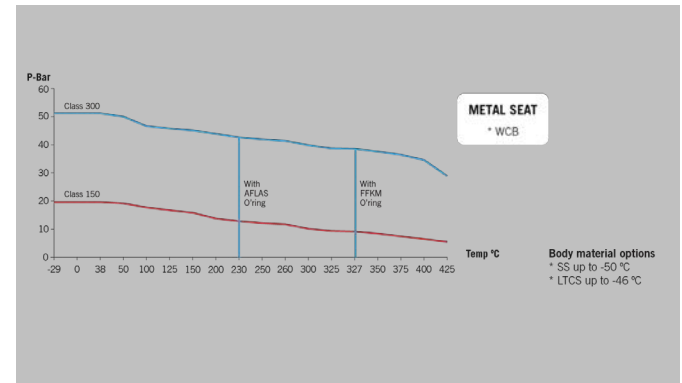
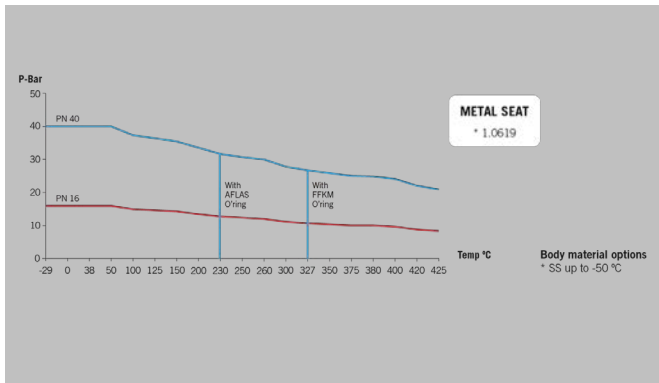
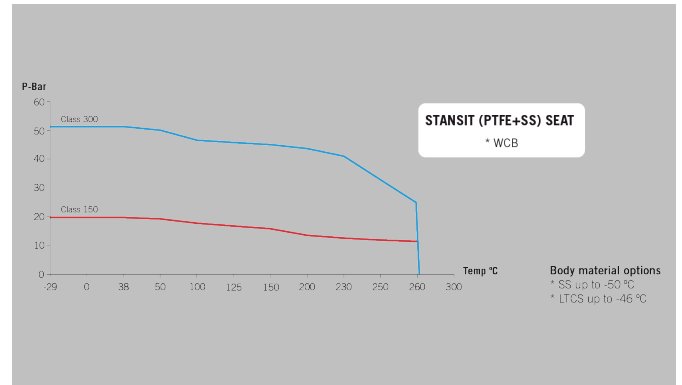
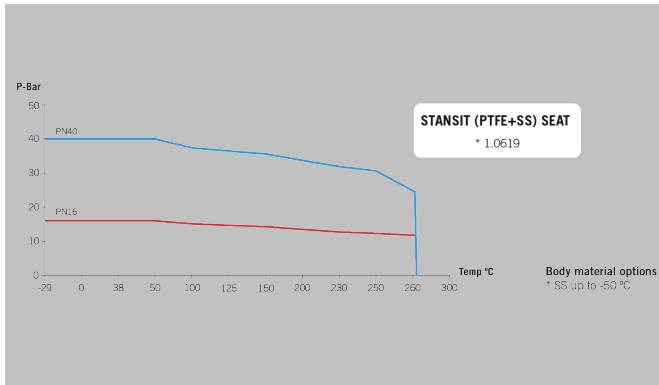

DIN & ANSI Ball Valves

F l o a t i n g

Assembly with ACTREG Pneumatic Actuator + Positioner. Digital positioners can be used in a conventional 4-20 mA or can also be used with HART, Fieldbus, or Profibus communication protocols.



Actreg High Performance Actuator, specially designed for the more demanding applications.



Assembly with lockable Lever for different valve positions.



Assembly with Electric Actuator. JC can supply different Electric Actuators as per customer demands.



Ball valves can also be delivered free stem.



Big stock of 60° balls. Other V-Port constructions under request.