

HAMMER UNIONS AND SWIVEL JOINTS





Quality and Innovation



Sara manufactures a diverse range of oilfield equipment in its manufacturing facility in India, using the latest design techniques and CNC machines. These products are available through distributors worldwide, including Sara's subsidiary company (STS Products, Inc.) in Houston, Singapore and various Sara locations.



Material

Sara unions are manufactured from steel forgings using materials appropriate to specific pressure ratings.

End Connections

Sara unions are available in a choice of end connections. API line pipe threads are standard. Butt weld ends can be provided. Customer to specify schedule of pipe while ordering.

Sour Service

Sour service is available and all H₂S service parts of Sara unions conform to the latest NACE specifications.

Low Temperature Service

Sara unions can be supplied for low temperature applications with suitable impact value testing.

Interchangeability

All Sara union components of the same size and figure number are Weco interchangeable. All Sara union nuts have three hammer lugs.

Traceability

Sara unions are supplied with full traceability documentation for each component.

Hammer Union Quick Reference Chart

Assembly Colour Key for Standard Service	Pressure Rating (psi)				Nominal Pipe Size (in mm.)												
	Standard Service		Sour Gas Service		1"	1 1/4"	1 1/2"	2"	2 1/2"	3"	4"	5"	6"	8"	10"	12"	
	Cold Working	Test	Cold Working	Test	25	32	40	50	65	80	100	125	150	200	250	300	
Fig. No.																	
50		500	750	NA	NA						✓	✓					
100		1,000	1,500	NA	NA				✓	✓	✓	✓	✓	✓	✓		
200		2,000	3,000	NA	NA	✓	✓	✓	✓	✓	✓	✓	✓	✓	✓	✓	
206		2,000	3,000	NA	NA	✓	✓	✓	✓	✓	✓	✓	✓	✓	✓	✓	
207		2,000	3,000	NA	NA					✓	✓		✓				
211		2,000	3,000	NA	NA				✓	✓							
400		2,500	3,750	2,500	3,750								✓	✓	✓	✓	
400		4,000	6,000	4,000	6,000				✓	✓	✓						
600		6,000	9,000	NA	NA	✓			✓	✓	✓						
602		6,000	9,000	6,000	9,000	✓	✓	✓	✓	✓	✓						
1002		10,000	15,000	7,500	11,250	✓	✓	✓	✓	✓	✓	✓	✓				
1003		10,000	15,000	7,500	11,250				✓	✓	✓	✓					
1502		15,000	22,500	10,000	15,000	✓			✓	✓	✓	✓					
2002		20,000	30,000	NA	NA				✓	✓	✓						
2202		NA	NA	15,000	22,500				✓	✓	✓						

Maximum Non-shock Test Pressure (PSI)

Temperature (Degrees F)

Figure No.	-20 +100	150	200	250	300	350	400	450	500	550
50*	500	464	437	409	382	355				
100/101*	1,000	927	873	818	764	709	655	600	546	509
200/201*/206*/207*	2,000	1,855	1,745	1,636	1,527	1,418	1,309	1,200	1,091	1,018
400/401*/402*	4,000	3,709	3,491	3,273	3,054	2,836	2,618	2,400	2,182	2,036
600/601*/602*	6,000	5,564	5,236	4,909	4,582	4,255	3,927	3,600	3,273	3,055
1002*/1003*	10,000	9,273	8,727	8,182	7,636	7,091				
1502*	15,000	13,910	13,091	12,273	11,454	10,637				

* Limited by rubber seal elements to 3,500 max.

FIG 50 UNION

500 PSI CWP

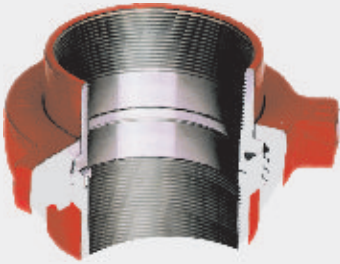

Recommended for air, water, oil, or gas service to 500 PSI NSCWP. Standard subs are threaded for API line pipe.

SIZE	LENGTH	NUT RADIUS	WEIGHT (Kg.)
5"	5 ^{1/2} "	5 ^{1/4} "	10.80

FIG 100 UNION

1,000 PSI CWP



Recommended for air, water, oil, or gas service to 1,000 PSI NSCWP. Standard subs are threaded for API line pipe and are Weeco interchangeable. Also available with

SIZE	LENGTH	NUT RADIUS	WEIGHT (Kg.)
2"	3 ^{5/8} "	2 ^{29/32} "	2.60
2 ^{1/2} "	4 ^{9/32} "	3 ^{5/8} "	5.20
3"	5 ^{1/8} "	4"	6.20
4"	5 ^{3/4} "	4 ^{11/16} "	10.20
5"	6 ^{33/64} "	5 ^{9/16} "	13.80
6"	6 ^{7/8} "	6 ^{7/8} "	23.20
8"	7 ^{5/16} "	7 ^{13/16} "	32.20

FIG 200 UNION

2,000 PSI CWP

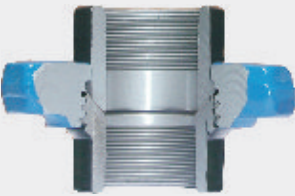

Recommended for air, water, oil, or gas service to 2000 PSI NSCWP. A union of great utility meeting most requirements in the medium pressure ranges. Precision seating surfaces assure dependable pressure seal. Standard subs are threaded for API line pipe and are Weeco interchangeable. Sizes of 2" and above also

SIZE	LENGTH	NUT RADIUS	WEIGHT (Kg.)
1 ^{3/4} "	2 ^{19/32} "	2"	1.00
1 ^{1/4} "	2 ^{25/32} "	2 ^{5/32} "	1.60
1 ^{1/2} "	2 ^{29/32} "	2 ^{13/32} "	1.60
2"	3 ^{1/4} "	2 ^{29/32} "	2.40
2 ^{1/2} "	4 ^{1/4} "	3 ^{5/8} "	4.50
3"	4 ^{17/32} "	4 ^{1/4} "	6.60
4"	4 ^{15/16} "	5"	9.60
5"	7 ^{3/64} "	5 ^{23/32} "	19.00
6"	6 ^{25/32} "	6 ^{1/2} "	22.00
8"	7 ^{5/16} "	7 ^{13/16} "	29.10
10"	9 ^{3/32} "	9 ^{1/16} "	41.36

FIG 206 UNION

2,000 PSI CWP

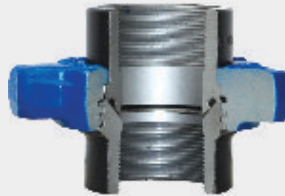

Recommended for air, water, oil or gas service to 2,000 PSI NSCWP. A Buna-N 'O' ring is mounted on the plain sub to provide an additional seal. Subs and nuts of the Fig. 206 union are interchangeable with the Fig. 200 union. Standard subs are threaded for API line pipe. Sizes of 2" and above

SIZE	LENGTH	NUT RADIUS	WEIGHT (Kg.)
1"	2 ^{19/32} "	2"	1.00
1 ^{1/4} "	2 ^{25/32} "	2 ^{5/32} "	1.07
1 ^{1/2} "	2 ^{29/32} "	2 ^{13/32} "	1.07
2"	3 ^{1/4} "	2 ^{29/32} "	2.40
2 ^{1/2} "	4 ^{1/4} "	3 ^{5/8} "	5.02
3"	4 ^{17/32} "	4 ^{1/4} "	6.60
4"	4 ^{15/16} "	5"	9.10
6"	6 ^{25/32} "	6 ^{1/2} "	19.30
8"	7 ^{5/16} "	7 ^{13/16} "	29.10
10"	9 ^{3/32} "	9 ^{1/16} "	41.36

FIG 207 UNION

2,000 PSI CWP



Recommended for air, water, oil, or gas service to 2,000 PSI NSCWP. A blanking cap with Buna-N 'O' ring seal provides an efficient and dependable closure. The threaded sub is interchangeable with Fig. 200 threaded sub. Also available with butt

SIZE	LENGTH	NUT RADIUS	WEIGHT (Kg.)
3"	3 ^{3/4} "	2 ^{3/4} "	4.45
4"	4 ^{45/64} "	3 ^{17/32} "	7.38
6"	5 ^{37/64} "	4 ^{27/32} "	17.10

FIG 211 UNION

2,000 PSI CWP

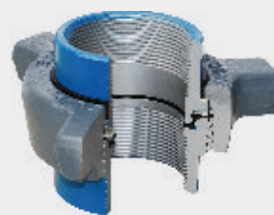

Recommended for production systems with electrolytic corrosion problems

Laminated insulating rings provide 35 million Ohms resistance across the union. O-ring in male sub provides a positive primary seal. Seal ring in female sub delivers a positive secondary seal.

SIZE	LENGTH	NUT RADIUS	WEIGHT (Kg.)
2"	3 ^{29/64} "	3 ^{1/16} "	3.00
3"	4 ^{35/64} "	4 ^{17/64} "	6.40

FIG 400 UNION

4,000 PSI CWP

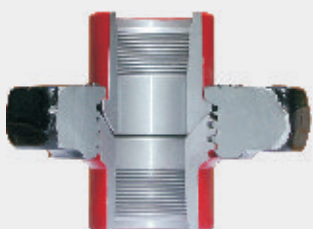

Recommended for air, water, oil, or gas service to 4,000 PSI NSCWP. Utilizes precision ball and cone seating surfaces for easy alignment and dependable pressure seal. Sizes over 4" are rated to 2,500 PSI NSCWP. Also available with a lip-type seal in 2"

SIZE	LENGTH		NUT RADIUS	WEIGHT (Kg.)
	TOTAL	CTR. BR.		
2"	5 ^{1/4} "	1 ^{1/4} "	3 ^{9/16} "	5.80
3"	6"	3/8"	4 ^{1/4} "	9.40
4"	8 ^{7/32} "	3/8"	5"	14.40
6"	11 ^{1/32} "	3/8"	6 ^{5/8} "	28.80
8"	11 ^{13/32} "	3/8"	7 ^{5/8} "	42.70
10"	10 ^{37/64} "	-	9 ^{49/64} "	56.80
12"	10 ^{7/8} "	3/8"	10 ^{1/4} "	74.43

FIG 600 UNION

6,000 PSI CWP



Recommended for air, oil, gas or steam service to 6,000 PSI NSCWP. Rugged and fast 2 pitch acme thread makes this the quickest union to make-up or break out (only two turns). The threaded sub is fitted with a bronze seat insert for added

SIZE	LENGTH		NUT RADIUS	WEIGHT (Kg.)
	TOTAL	CTR. BR.		
1"	3 ^{9/16} "	1/4"	2 ^{5/32} "	1.59
1 ^{1/2} "	4 ^{7/8} "	1/4"	3 ^{7/32} "	4.30
2"	6 ^{7/16} "	1/4"	3 ^{3/4} "	6.80
2 ^{1/2} "	7 ^{9/16} "	3/8"	4 ^{1/4} "	9.10
3"	8 ^{11/16} "	3/8"	4 ^{1/2} "	13.18
4"	10 ^{1/16} "	3/8"	5 ^{1/4} "	18.63

* All weights are approximate. NSCWP - Non Shock Cold Working Pressure

FIG 602 UNION 6,000 PSI CWP

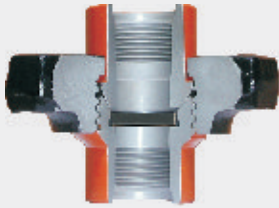

Recommended for air, water, oil, gas or mud service to 6,000 PSI NSCWP. This union has a replaceable lip-type seal ring of Buna-N specifically designed to minimize fluid flow turbulence. Lip-type ring provides a pressure seal and protection for metal-to-metal seating surfaces. Smaller and lighter than Fig. 600 unions and are recommended for manifold and truck mounting where size and

SIZE	LENGTH		NUT RADIUS	WEIGHT (Kg.)	LENGTH BUTT. WELD SCH. 80
	TOTAL	CTR. BR.			
1"	3 ^{17/32"}	1/4"	2 ^{5/32"}	1.59	3 ^{17/32"}
1 ^{1/4"}	4 ^{29/32"}	1/4"	3 ^{7/32"}	4.54	4 ^{11/16"}
1 ^{1/2"}	4 ^{29/32"}	1/4"	3 ^{7/32"}	4.10	4 ^{11/16"}
2"	5 ^{1/4"}	1/4"	3 ^{3/4"}	5.90	5 ^{1/32"}
3"	6 ^{1/4"}	3/8"	4 ^{1/2"}	10.45	5 ^{7/16"}
4"	8 ^{1/4"}	3/8"	5 ^{7/32"}	15.00	6 ^{1/16"}

FIG 1002 UNION 10,000 PSI CWP

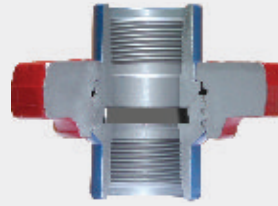

Recommended for air, water, oil, gas and mud service to 10,000 PSI NSCWP. This union has a replaceable lip-type seal ring of Buna-N specifically designed to minimize fluid flow turbulence. The lip-type ring works similarly as in the Fig. 602 union. These unions are for use on high

SIZE	LENGTH		NUT RADIUS	WEIGHT (Kg.)	LENGTH BUTT. WELD SCH. 80 XX HVY	
	TOTAL	CTR. BR.				
1"	3 ^{17/32"}	1/4"	2 ^{5/32"}	1.59	3 ^{17/32"}	-
1 ^{1/4"}	4 ^{7/8"}	1/4"	3 ^{7/32"}	4.54	-	-
1 ^{1/2"}	4 ^{7/8"}	1/4"	3 ^{7/32"}	4.10	4 ^{11/16"}	-
2"	5 ^{1/4"}	1/4"	3 ^{3/4"}	6.00	5 ^{1/32"}	-
2 ^{1/2"}	6 ^{1/8"}	3/8"	4 ^{1/4"}	7.95	5 ^{1/8"}	-
2 ^{1/2"} EUE	5 ^{15/16"}	3/8"	4 ^{1/4"}	7.95	-	-
3"	6 ^{1/4"}	3/8"	4 ^{1/2"}	10.00	5 ^{3/8"}	5 ^{3/8"}
4"	8 ^{1/4"}	3/8"	5 ^{7/32"}	17.95	5 ^{11/16"}	-
5"	-	-	6 ^{1/4"}	25.90	5 ^{15/16"}	6 ^{1/8"}

5" size rated at 7,500 PSI CWP and 11,250 PSI test, 5" unions for sour gas rated at 5,000 PSI CWP and 7,500 PSI test.

FIG 1003 UNION 10,000 PSI CWP



Recommended for high pressure manifolding and drilling rig use where alignment of piping components is a problem. Recommended for air, water, oil, gas or mud service to 10,000 PSI NSCWP. This union has a ball seat that allows a total of 15° (±7½°) angular adjustment. An 'O' ring seal in addition to the metal-to-metal seat assures a pressure

SIZE	LENGTH		NUT RADIUS	WEIGHT (Kg.)
	TOTAL	CTR. BR.		
2"	4 ^{3/4"}	-	3 ^{1/2"}	05.64
3" LP THD	9 ^{1/8"}	3/8"	4 ^{7/8"}	20.45
3" SCH 160	8 ^{7/8"}	-	4 ^{7/8"}	21.60
3" XX HVY	9 ^{1/8"}	-	4 ^{7/8"}	22.00
4" LP THD	10 ^{15/16"}	1/2"	6"	32.95
4" SCH 160	10 ^{11/16"}	-	6"	34.54
4" XX HVY	10 ^{15/16"}	-	6"	35.45
5" SCH 160	10 ^{9/16"}	-	6"	33.63
5" XX HVY	10 ^{15/16"}	-	6"	34.77

5" size rated at 7,500 PSI CWP and 11,250 PSI test, 5" unions for sour gas rated at 5,000 PSI CWP and 7,500 PSI test

* All weights are approximate. NSCWP - Non Shock Cold Working Pressure

FIG 1502 UNION 15,000 PSI CWP

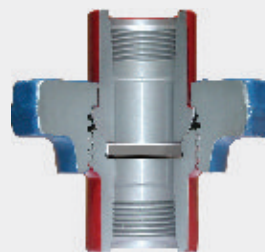

Recommended for air, water, oil, gas and mud service to 15,000 PSI NSCWP. This union has a replaceable lip-type seal ring of Buna-N specifically designed to minimize fluid flow turbulence. The lip-type ring also provides a pressure seal and protection for metal-to-metal seating surface and are recommended for manifold and truck

SIZE	LENGTH		NUT RADIUS	WEIGHT (Kg.)	LENGTH BUTT. WELD XX HVY
	TOTAL	CTR. BR.			
1"	4 ^{3/8"}	1/4"	2 ^{3/4"}	3.82	-
2"	7"	1/4"	4"	9.54	6 ^{1/4"}
3"	7 ^{5/8"}	3/8"	4 ^{13/16"}	14.10	5 ^{1/4"}
4"	8 ^{1/2"}	1/2"	6 ^{1/16"}	34.00	-
5"	9 ^{7/64"}	-	6 ^{45/64"}	44.40	-

Derates to 10,000 PSI WP for sour service

FIG 2002 UNION & FIG 2202 UNION

20,000 PSI CWP

15,000 PSI CWP

Recommended for standard service to 20,000 PSI NSCWP. Available in butt weld end connections only.

Available as Fig 2202 for sour service (15,000 PSI WP).

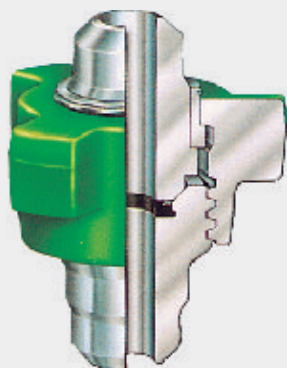

SIZE	LENGTH	NUT RADIUS	WEIGHT (Kg.)
2"	7 ^{3/8"}	3 ^{23/32"}	10.45
3"	8 ^{5/8"}	6 ^{5/32"}	21.80
4"	8 ^{1/2"}	6"	34.50

FIG YH - 110 UNION

500 - 6,000 PSI CWP

Recommended for use in flow lines to isolate for cathodic protection. The sealing action is provided by 'O' Rings fitted into a machined groove between the two metal mating parts. The metal parts are separated by non-conductor gaskets that avoid penetration to flow, seepage and resistant to acids, chemicals and temperatures encountered in normal service. Maximum temperature is 250° F.



SIZE	CWP	TP	COLOR	
			Subs	Nut
2" - 3"	500	750	Maroon	Maroon
1" - 4"	1,000	1,500	Maroon	White
1/4" - 4"	2,500	3,750	Orange	Orange
1" - 3"	4,000	6,000	Brown	Brown
1/4" - 1/2"	6,000	9,000	Blue	Blue

FIG YH - 210 BLANKING UNION

1,000 - 6,000 PSI CWP

Designed for use on manifolds, jumper assemblies and other installations where a blank cap connection is required. This Union can be interchanged with subs of fig YH-300, if required. The cap is furnished blank as standard, but can be drilled and tapped for a 1/8"-1" NPT for a bleeder plug.



SIZE	CWP	TP	COLOR	
			Subs	Nut
2" - 6"	1,000	1,500	Yellow	Gray
2" - 4"	2,500	3,750	Pearl Gray	Green
2" - 3"	4,000	6,000	Pearl Gray	Red
2"	6,000	9,000	Pearl Gray	Blue

FIG YH - 300 UNION

500 - 12,500 PSI CWP

It is a flat face Union with 'O'-Ring fitted into the groove of the female sub. The 'O'-Ring is completely enclosed with the flat face of mating part and becomes more effective as additional pressure is applied.



SIZE	CWP	TP	COLOR	
			Subs	Nut
2" - 8"	500	750	Yellow	Black
1" - 7"	1,000	1500	Yellow	Gray
1/4" - 6"	2,500	3750	Pearl Gray	Green
1/4" - 6"	4,000	6000	Pearl Gray	Red
1" - 4"	6,000	9000	Pearl Gray	Blue
1" - 2"	10,000	15000	Pearl Gray	Orange
1/4" - 1"	12,500	18750	Silver	Silver

* All weights are approximate. NSCWP - Non Shock Cold Working Pressure

MUD TANK SEAL UNION

150 PSI CWP

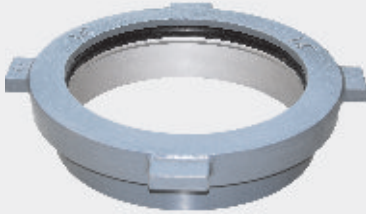

Recommended for

Mud tanks, mud tank connecting lines, and pump suction flanges

- Nitrile seal provides a compression seal.
- Elongated cross-section of seal ring ensures greater sealing surface when in contact with the pipe.
- Accepts up to 7° pipe misalignment.
- 6, 8, and 10-inch sizes require butt-weld.



SIZE	CONNECTS NOMINAL SIZE OILFIELD PIPE	FEMALE COMPONENT WELDS TO	COMPLETE ASSEMBLY	O-RING ONLY
3"	3-Inch (3 1/2" O.D.)	4-Inch	8.00	0.18
4"	4-Inch (4 1/2" O.D.)	6-Inch	10.50	0.24
6"	6-Inch (6 5/8" O.D.)	8-Inch	14.80	0.36
8"	8-Inch (8 5/8" O.D.)	10-Inch	20.00	0.48
10"	10-Inch (10 3/4" O.D.)	12-Inch	24.00	0.60
12"	12-Inch (12 3/4" O.D.)	14-Inch	27.50	0.72
13"	13-Inch (13 3/8" O.D.)	13-Inch (Casing)	25.50	0.77
14"	14-Inch (14" O.D.)	16-Inch	24.50	0.84
16"	16-Inch (16" O.D.)	18-Inch	44.00	0.96
18"	18-Inch (18" O.D.)	20-Inch	53.00	1.08
20"	20-Inch (20" O.D.)	22-Inch	67.50	1.44

AIR SEAL UNION

150 PSI CWP

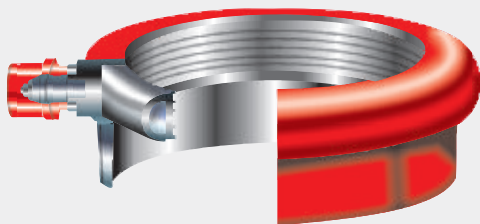

Recommended for

Mud suction lines, return lines, low pressure fluid lines.

- Inflatable tube is used to provide tight seal.
- Rig air is used to inflate the tube.
- Sealing is maintained even if pipe is mis-aligned.
- Available in 4, 6, 8, 10, 12 and 16".

SIZE	APPROX. WT. (Kg.) COMPLETE UNION	APPROX. WT. (Kg.) TUBE ONLY
4"	3.20	0.38
6"	8.20	0.67
8"	10.00	0.77
10"	11.80	1.15
12"	13.60	1.54
16"	20.40	1.68

Suction-Hose Unions

500 PSI (34 bar) Maximum Line Pressure, 4, 5, and 6" sizes

Sara manufactures a range of Suction-hose and Frac Tank Unions in 4", 6" and 8" sizes in pressures ranging from 500 to 1,000 PSI CWP.



Line Pipe Threads

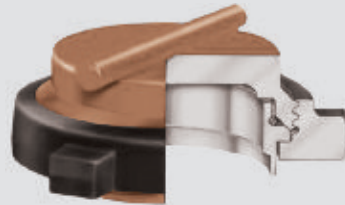

Socket Weld with Female Plug Assembly



Socket weld

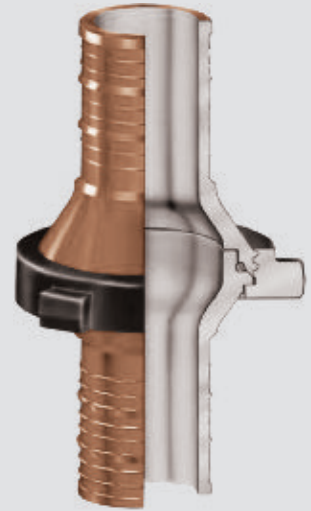

Hose Nipple

Frac Subs/Hose Unions

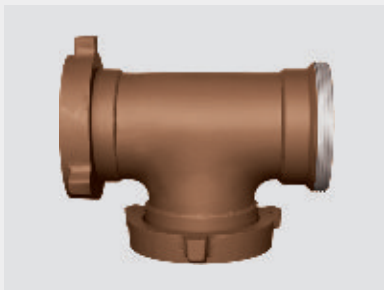

Swivel Joints



Available in sizes 3/4" through 3" up to 15,000 PSI non-shock cold working pressure, Sara Swivel Joints offer the following features...

- Minimum flow restriction.
- Heavy duty hex head style ball loading plug.
- Grease retainer ring (ensures clean ball race).
- Standard packing units (Operating temperature up to 225 °F).
- High temperature packing units (Operating temperature up to 450 °F).
- Superior hardened ball races ensure uniform surface hardness and depth for longer life under severe thrust and radial loading.

Standard Swivel Joints are provided with API line pipe threads.

Other end connections are available on request.

Available for standard and sour service.

All sizes are available in 8 styles, for 360° rotation in 1, 2 or 3 planes.

Quick Reference Chart

Standard Service

MODEL	COLOR CODE	NSCWP	END CONNECTIONS	SIZE (in)						SIZE (in)						
				3/4	1 ^{1/4}	1 ^{1/2}	1	2	3	3/4	1 ^{1/4}	1 ^{1/2}	1	2	3	
Low Pressure	BLUE	1000	Female Line Pipe Threads					✓	✓							
High Pressure	OLIVE GREEN	6,000	Fig. 602 Union												✓	✓
Extra High Pressure Long Sweep	SILVER	6,000	Female Line Pipe Threads	✓	✓	✓	✓	✓	✓							
	OLIVE GREEN	7,500	Fig. 1002 Union												✓	✓
	OLIVE GREEN	10,000	Fig. 1502 Union												✓	✓
	BLACK	10,000	Female Line Pipe Threads					✓	✓							
	OLIVE GREEN	15,000	Fig. 2202 Union												✓	✓
	RED	15,000	Fig. 1502 Union					✓	✓							
	LIGHT BLUE	20,000	Fig. 2002 Union					✓	✓							

NSCWP - Non Shock Cold Working Pressure

Swivel Joints

Short Radius Swivel Joints

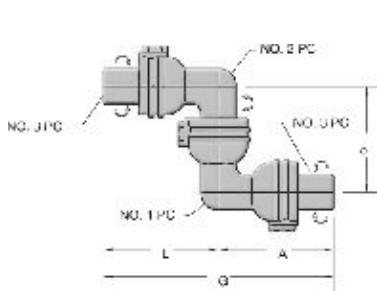

Style No. 10
(Three Planes of Rotation)

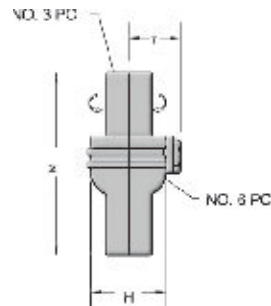

Style No. 20
(One Plane of Rotation)

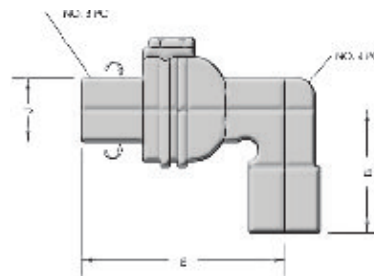

Style No. 30
(One Plane of Rotation)

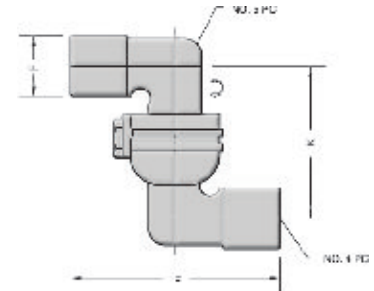

Style No. 40
(One Plane of Rotation)

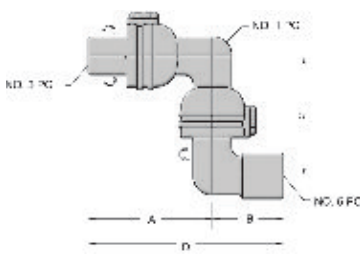

Style No. 50
(Two Planes of Rotation)

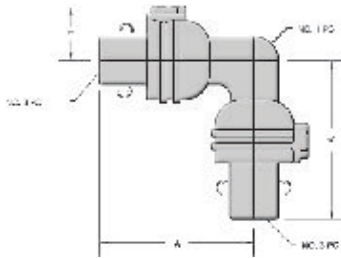

Style No. 60
(Two Planes of Rotation)

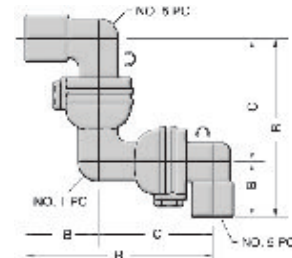

Style No. 70
(Two Planes of Rotation)

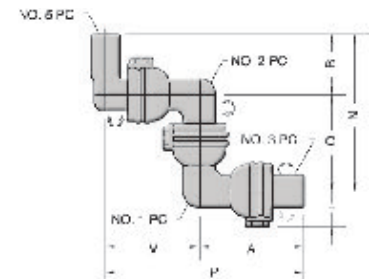

Style No. 80
(Three Planes of Rotation)

SIZE (Inches)	A	B	C	D	E	F	G	H	J	K	L	M	N	O	P	R	S	T	V
3/4", 1"	4 ^{5/8}	2 ^{23/32}	4 ^{7/32}	7 ^{11/32}	5 ^{7/16}	1 ^{3/4}	9 ^{1/4}	2 ^{7/16}	1 ^{3/4}	4 ^{7/32}	4 ^{5/8}	5 ^{3/16}	6 ^{15/16}	4 ^{7/32}	8 ^{27/32}	6 ^{15/16}	4 ^{5/8}	1 ^{7/8}	4 ^{7/32}
1" 1/4", 1" 1/2"	4 ^{23/32}	3 ^{3/16}	4 ^{9/32}	7 ^{29/32}	6 ^{3/8}	2 ^{1/2}	9 ^{7/16}	2 ^{7/8}	2 ^{3/8}	4 ^{9/32}	4 ^{23/32}	5 ^{15/32}	7 ^{15/32}	4 ^{9/16}	9 ^{9/16}	7 ^{15/32}	4 ^{23/32}	2 ^{1/8}	4 ^{27/32}
2"	5 ^{27/32}	4 ^{1/32}	5 ^{7/8}	9 ^{7/8}	8 ^{1/16}	3 ^{1/8}	12 ^{5/16}	4 ^{1/8}	3 ^{5/16}	5 ^{7/8}	6 ^{15/32}	6 ^{21/32}	10 ^{1/32}	6	12 ^{11/32}	9 ^{29/32}	5 ^{27/32}	2 ^{21/32}	6 ^{1/2}
2 1/2"	7 ^{1/8}	4 ^{7/8}	7 ^{11/16}	12	9 ^{3/4}	4	14 ^{1/4}	4 ^{1/2}	3 ^{3/4}	7 ^{11/16}	7 ^{1/8}	8 ^{1/4}	12 ^{9/16}	7 ^{11/16}	14 ^{13/16}	12 ^{9/16}	7 ^{1/8}	2 ^{15/16}	7 ^{11/16}
3"	8 ^{5/8}	4 ^{5/8}	7 ^{15/16}	13 ^{1/4}	9 ^{1/4}	4 ^{5/16}	18 ^{1/16}	5 ^{13/16}	4 ^{1/2}	8 ^{3/4}	9 ^{7/16}	9 ^{1/8}	12 ^{9/16}	7 ^{15/16}	17 ^{3/8}	12 ^{9/16}	9 ^{7/16}	3 ^{3/8}	8 ^{3/4}

Swivel Joints

Pup Joints

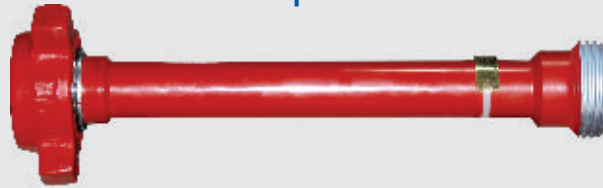

Available with integral, welded or NPST union end connections from 10,000 to 15,000 PSI NSCWP for standard and sour service.

Steel Hose Assemblies

High pressure cementing and circulating hoses incorporate swivel joints of forged steel with superior quality hardened ball races and high pressure type packing units.

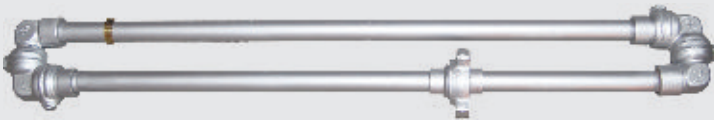

One wing union and two style 50 or style 10 swivel joints with threaded ends.



- One wing union and one each style 50 and style 10 swivel joints with integral wing union ends.
- Four wing unions and two style 50 or style 10 swivel joints with integral wing union ends.
- Four wing unions and two style 50 or style 10 swivel joints.

Long Radius Swivel Joints

All models are made from closed die forged alloy steel body members.



Style No. 10
M x M Union Ends



Style No. 50
M x F Union Ends



Style No. 10
M x F Union Ends



Style No. 10
Threaded Ends



Style No. 50
Threaded Ends



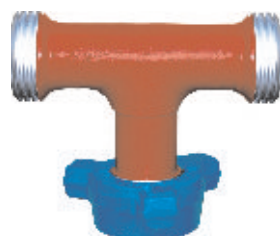

Other Products





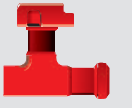
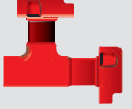
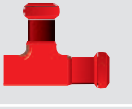

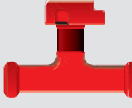

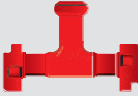

Sara also manufactures Flange to Wing Adapters, Wing to Wing Adapters, Flanged Tees and Crosses and an assortment of other products having usage in varied oilfield applications.

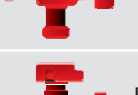

Flange to Union Crossover

Integral Fitting Specifications

Nom. Size in.			1	1.5	2		3			4			
Figure No.			1502	1502	602	1502	2002	602	1502	2002	602	1002	1502
CWP (PSI)			15,000	15,000	6,000	15,000	20,000	6,000	15,000	20,000	6,000	10,000	15,000
Longsweep Elbow		F x M Wt. (Kg.)	-	-	10	12.6	-	24.5	22.9	-	40.4	40.4	-
Elbows		F x M Wt. (Kg.)	-	-	12.4	14.7	-	45.6	46.3	100	-	-	-
		M x M Wt. (Kg.)	-	-	16.3	18.5	-	52.2	54.9	-	-	-	-
		F x F Wt. (Kg.)	-	-	8.2	10.9	-	38.1	39.5	-	-	-	-
Tees		F x F x F Wt. (Kg.)	13.2	15.4	12	13.2	14.5	50.8	51.7	99.8	44.9	45.8	90.7
		F x F x M Wt. (Kg.)	14.4	18	14.2	17	19	56.2	58	115	51.7	52.6	106
		F x M x F Wt. (Kg.)	14.4	18	14.2	17	19	56.2	58	115	51.7	52.6	106
		F x M x M Wt. (Kg.)	15.9	21.1	16.3	20.9	23.6	61.7	64.4	129	57.6	59	122

Nom. size in.		1	1.5	2			3		4			
Figure No.		1502	1502	602	1502	2002	602	1502	2002	602	1002	1502
CWP (PSI)		15,000	15,000	6,000	15,000	20,000	6,000	15,000	20,000	6,000	10,000	15,000
Tees	 M x M x F Wt. (Kg.)	15.9	21.1	16.3	20.9	23.6	61.7	64.4	129	57.6	59	122
	 M x M x M Wt. (Kg.)	17.2	23.6	18.6	24.7	28.1	67.1	70.8	144	64	64.9	137
Longsweep Elbow	 M X M Wt. (Kg.)	-	-	12.2	34 15.4	-	30	29.5	-	46.3	46.3	-
Crosses	 F x F x F x F Wt. (Kg.)	-	31.8	26.3	26.8	-	71.2	61.7	-	65.3	65.5	-
	 F x F x M x F Wt. (Kg.)	-	35	28.1	30	-	76.2	80.7	-	71.2	71.2	-
	 F x F x M x M Wt. (Kg.)	-	37.6	30.4	33.1	-	81.6	83	-	77.1	77.1	-
	 F x M x M x F Wt. (Kg.)	-	37.6	30.4	33.1	-	81.6	83	-	77.1	77.1	-
Crosses	 F x M x M X M Wt. (Kg.)	-	40.4	32.7	36.3	-	87.1	89.4	-	83	83	-
	 M x M x M x M Wt. (Kg.)	-	142.6	35	39.5	-	92.1	95.7	-	89.4	89.4	-
Laterals	 M x F x F Wt. (Kg.)	26.3	27.9	21.5	24.3	-	-	40.1	-	53.1	78.9	141
	 F x F x F Wt. (Kg.)	25.4	-	-	-	-	-	40.9	-	-	-	-
Wyes	 M x F x F Wt. (Kg.)	-	20	12.7	12.2	12.7	-	-	-	-	-	-

Products Catalog





Australia's largest stockist of hammer unions and swivels

[Click here](#) for our stock list.

Contact: sales@globalsupplyline.com.au

Sales

7 Pritam Road, Dehra Dun

248001 (Uttarakhand)

India

Phone : +91.135.672395, 2674815, 2677759

Fax : +91.135.2673109, 2640357

Registered Office

E-30, Anand Niketan, Basement

New Delhi-110021

India

Phone : +91.11.24115804, 24119220

Fax : +91.11.24115804

SARA SAE has produced this brochure for general information only, and it is not intended for design purposes. Although every effort has been made to maintain the accuracy and reliability of its contents, SARA SAE in no way assumes responsibility for liability for any loss, damage or injury resulting from the use of information and data herein. All applications for the material described are at the user's risk and are the user's responsibility. All brands listed are trademarks of SARA SAE.



www.sarasae.com

ssae@sarasae.com